



给您一颗快乐的“芯”！

YSO680PR



Features

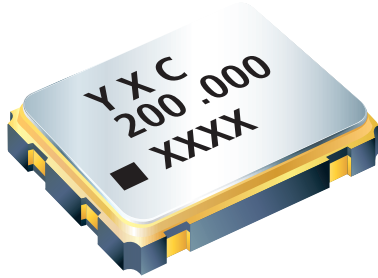

- Quartz Crystal Programmable Oscillator
- Any frequency between 1MHz~200MHz accurate to 6 decimal places
- Operating temperature from -40 to +85
- CMOS compatible output
- Industry-standard packages: 2.5 x 2.0 , 3.2 x 2.5 , 5.0 x 3.2 , 7.0 x 5.0 mm x mm

Applications:

- Ideal for e-Books, clock for MPU, Consumer electronics, etc

Electrical Specifications

All Min and Max limits are specified over temperature and rated operating voltage with 15 pF output load unless otherwise stated. Typical values are at 25°C and nominal supply voltage.

Parameter	1.8 V	2.5 V	3.3 V
Frequency Range	1MHz~110MHz	1MHz~166MHz	1MHz~200MHz
Supply Voltage Variation(Vdd)10%	1.62 V~1.98 V	2.25 V~2.75 V	2.97 V~3.63 V
Standby Current	15 μ A		
Frequency Tolerance	± 20 ppm, ± 25 ppm, ± 50 ppm, or specify		
Output Load	15 pF, or specify		
Operating Temperature Range	- 40 ~ + 85 $^{\circ}$ C, or specify		
Storage Temperature Range	- 55 ~ + 125 $^{\circ}$ C		
Voltage Vol (Max.) / Vol (Min.)	VOH=90%Vdd / VOL=10%Vdd		
Duty Cycle	45~55%		
Start-up Time	10ms Max.		
Supply Current	See Below		
Frequency Aging (at 25 $^{\circ}$ C)	± 3 ppm / year Max.		

Pin Description

Pin	Symbol		Functionality
1	OE/ $\overline{\text{ST}}$ /NC	Output Enable	Pin 1=H: Specified frequency output Pin 1=L: Pin 3 output is low. Specified frequency output stop.
		Standby	Pin 1=H: Specified frequency output Pin 1=L: Pin 3 output is low. Device goes to sleep mode. Supply current reduces to 15uA(Standby Current).
		No Connect	Pin 1=VDD or Pin 1 is Open. Specified frequency output. Pin 1 has no function.
2	GND	Power	Electrical ground
3	OUT	Output	Oscillator output
4	VDD	Power	Power supply voltage

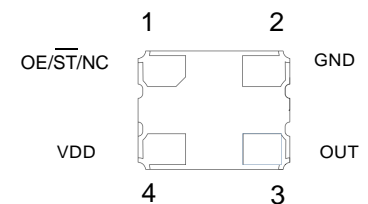

Pin Assignments



给您一颗快乐的“芯”！

YSO680PR



Dimensions and Patterns

Package Size – Dimensions (Unit: mm)	Recommended Land Pattern (Unit: mm)
<p>2.5 x 2.0 mm</p>	<p>TOP View Suggested Layout</p>
<p>3.2 x 2.5 mm</p>	<p>TOP View Suggested Layout</p>
<p>5.0 x 3.2 mm</p>	<p>TOP View Suggested Layout</p>
<p>7.0 x 5.0 mm</p>	<p>TOP View Suggested Layout</p>

Notes:

1. A capacitor of value 0.01μF~0.1μF or higher between Vdd and GND is required.



给您一颗快乐的“芯”!

YSO680PR



Performance Plots

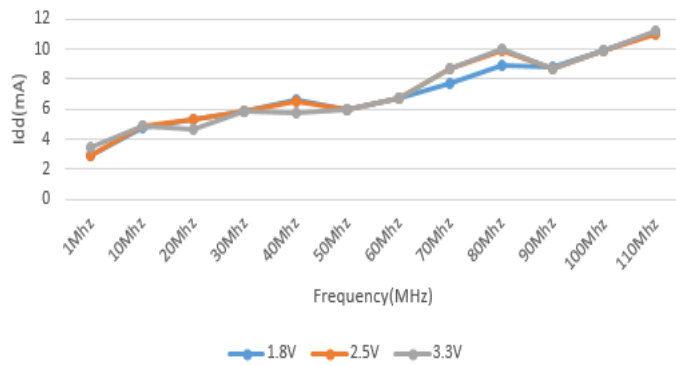

Figure 1. Idd vs Frequency

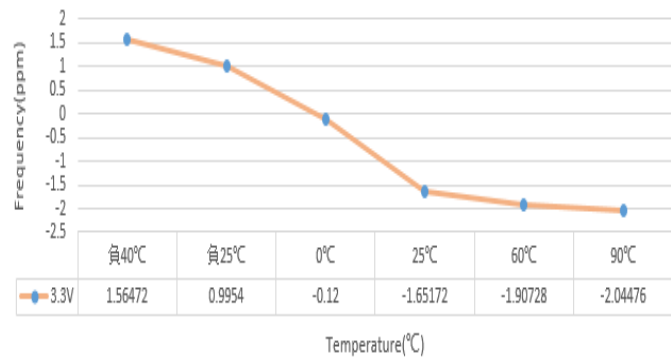

Figure 2. Frequency vs Temperature

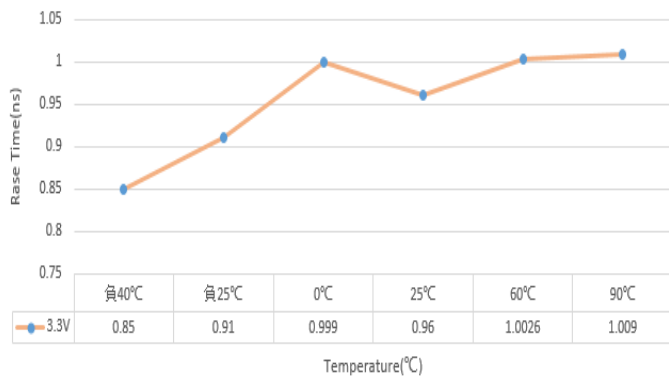

Figure 3. 20%-80% Rise Time vs Temperature

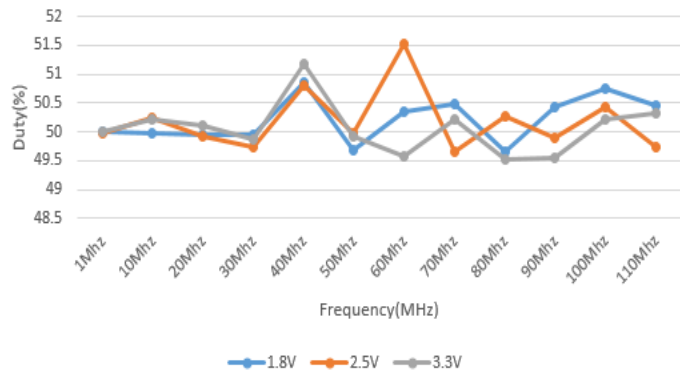

Figure 4. Duty Cycle vs Frequency

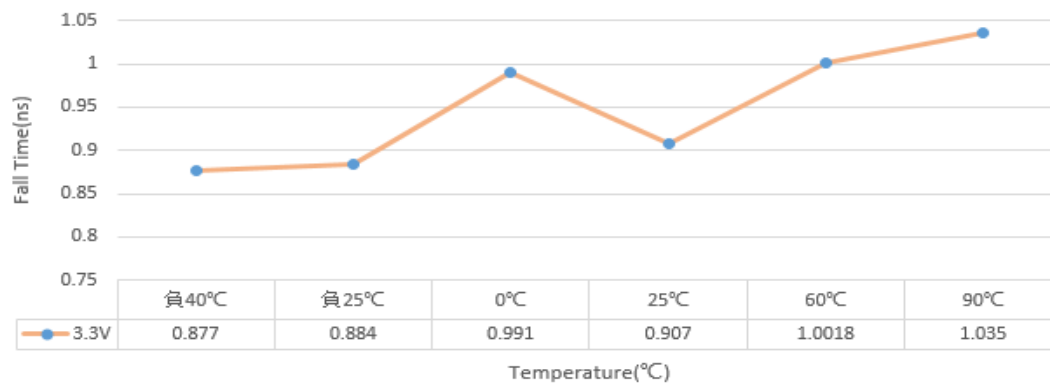

Figure 5. 20%-80% Fall Time vs Temperature

Notes:

1. All plots are measured with 15 pF load at room temperature, unless otherwise stated.
2. Phase noise plots are measured with Agilent E5052B signal source analyzer. Integration range is up to 5 MHz for carrier frequencies below 40 MHz.

come visit our site <http://www.yxc.hk>



给您一颗快乐的“芯”！

YSO680PR



★ PART NUMBER GUIDE 部件号示例 e.g. OP7050200MEDA4SI - u YSO680PR=7.0 ×5.0 SMD SEAM TYPE

Quartz Crystal Oscillator	Dimensions	Frequency (Hz)	Supply voltage (V)	Frequency Stability Overall (ppm)	output	Pin	Material	Operating Temp. Range	-	Remark
OP	7050	200M	E	D	A	4	S	I	-	u

★ INPUT CURRENT 工作电流

Supply Voltage	Power Dissipation				
	1.000 ~ 30.000 MHz	30.000 ~ 75.000 MHz	75.000 ~ 110.000 MHz	133.000 ~ 166.000 MHz	166.000 ~ 200.000 MHz
1.8 V	6 mA max	8 mA max	12 mA max	—	—
2.5 V	8 mA max	10 mA max	15 mA max	15 mA max	—
3.3 V	10 mA max	15 mA max	20 mA max	22 mA max	25 mA max

★ REFLOW SOLDERING PROFILE 回流焊特性

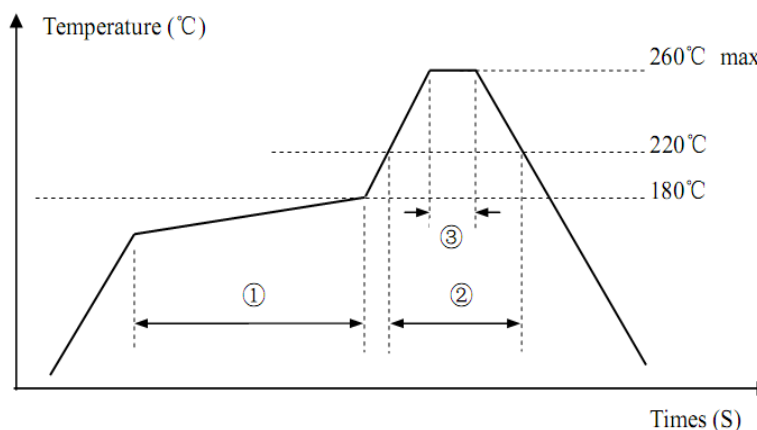

Pb free reflow A	①	Preheat	160~180°C	120sec. max
	②	Primary heat	220°C	60sec. max
	③	Peak	260°C	10sec. max.

★ Test Circuit 测试电路

