

SiT8256

0.3 ps Jitter Oscillator for Networking



Features

- 156.250000 MHz, 156.253906 MHz, 156.257800 MHz, 156.257812 MHz, 156.261718 MHz for Ethernet applications
- 100% pin-to-pin drop-in replacement to quartz-based oscillators
- Ultra low phase jitter: 0.3 ps
- Frequency stability as low as ±10 PPM
- Industrial or extended commercial temperature range
- LVCMOS/LVTTL compatible output
- Standby or output enable modes
- Standard 4-pin packages: 2.5 x 2.0, 3.2 x 2.5, 5.0 x 3.2, 7.0 x 5.0 mm²
- Outstanding silicon reliability of 2 FIT or 500 million hour MTBF
- Pb-free, RoHS and REACH compliant
- Ultra short lead time

Applications

- SATA, SAS, Ethernet, 10Gb Ethernet, XAUI
- Computing, storage, networking, telecom, industrial control



Electrical Characteristics

Parameter	Symbol	Min.	Typ.	Max.	Unit	Condition
Output Frequency Range	f	156.250000, 156.253906 156.257800, 156.257812 156.261718			MHz	
Frequency Stability	F_stab	-10	-	+10	PPM	Inclusive of Initial tolerance at 25 °C, and variations over operating temperature, rated power supply voltage and load
		-20	-	+20	PPM	
		-25	-	+25	PPM	
		-50	-	+50	PPM	
Operating Temperature Range	T_use	-20	-	+70	°C	Extended Commercial
		-40	-	+85	°C	Industrial
Supply Voltage	Vdd	1.71	1.8	1.89	V	Supply voltages between 2.5V and 3.3V can be supported. Contact SiTime for additional information.
		2.25	2.5	2.75	V	
		2.52	2.8	3.08	V	
		2.97	3.3	3.63	V	
Current Consumption	Idd	-	31	33	mA	No load condition, Vdd = 2.5V, 2.8V or 3.3V
		-	29	31	mA	No load condition, Vdd = 1.8V
OE Disable Current	I_OD	-	-	31	mA	Vdd = 2.5V, 2.8V or 3.3V, OE = GND, output is Weakly Pulled Down
		-	-	30	mA	Vdd = 1.8 V, OE = GND, output is Weakly Pulled Down
Standby Current	I_std	-	-	70	µA	Vdd = 2.5V, 2.8V or 3.3V, ST = GND, output is Weakly Pulled Down
		-	-	10	µA	Vdd = 1.8 V, ST = GND, output is Weakly Pulled Down
Duty Cycle	DC	45	-	55	%	
Rise/Fall Time	Tr, Tf	-	1.2	2	ns	15 pF load, 10% - 90% Vdd
		-	2.2	-	ns	30 pF load, 10% - 90% Vdd
		-	3.4	-	ns	45 pF load, 10% - 90% Vdd
Output Voltage High	VOH	90%	-	-	Vdd	IOH = -6 mA, IOL = 6 mA, (Vdd = 3.3V, 2.8V, 2.5V)
Output Voltage Low	VOL	-	-	10%	Vdd	IOH = -3 mA, IOL = 3 mA, (Vdd = 1.8V)
Input Voltage High	VIH	70%	-	-	Vdd	Pin 1, OE or ST
Input Voltage Low	VIL	-	-	30%	Vdd	Pin 1, OE or ST
Input Pull-up Impedance	Z_in	-	100	250	kΩ	Pin 1, OE logic high or logic low, or ST logic high
		2	-	-	MΩ	Pin 1, ST logic low
Startup Time	T_start	-	7	10	ms	Measured from the time Vdd reaches its rated minimum value
OE Enable/Disable Time	T_oe	-	-	150	ns	
Resume Time	T_resume	-	6	10	ms	In standby mode, measured from the time ST pin crosses 50% threshold. Refer to Figure 5.
RMS Period Jitter	T_jitt	-	1.5	2	ps	Vdd = 2.5V, 2.8V or 3.3V
		-	2	3	ps	Vdd = 1.8V
RMS Phase Jitter (random)	T_phj	-	0.25	0.3	ps	IEEE802.3-2005 10GbE jitter measurement specifications
First year Aging	F_aging	-1.5	-	+1.5	PPM	25°C
10-year Aging		-5	-	+5	PPM	25°C

Notes:

1. All electrical specifications in the above table are specified with 15 pF output load and for all Vdd(s) unless otherwise stated.
2. Contact SiTime for custom drive strength to drive higher or multiple load, or SoftEdge™ option for EMI reduction.

SiT8256

0.3 ps Jitter Oscillator for Networking



Pin Configuration

Pin	Symbol	Functionality	
1	OE/ \overline{ST}	Output Enable	H or Open ^[3] : specified frequency output L: output is high impedance. Only output driver is disabled.
		Standby	H or Open ^[3] : specified frequency output L: output is low (weak pull down). Device goes to sleep mode. Supply current reduces to I _{std} .
2	GND	Power	Electrical ground
3	OUT	Output	Oscillator output
4	VDD	Power	Power supply voltage

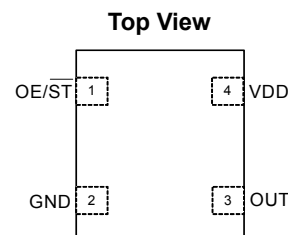

Note:

- A pull-up resistor of <math><10\text{ k}\Omega</math> between OE/ \overline{ST} pin and Vdd is recommended in high noise environment

Absolute Maximum

Attempted operation outside the absolute maximum ratings of the part may cause permanent damage to the part. Actual performance of the IC is only guaranteed within the operational specifications, not at absolute maximum ratings.

Parameter	Min.	Max.	Unit
Storage Temperature	-65	150	°C
VDD	-0.5	4	V
Electrostatic Discharge	–	2000	V
Soldering Temperature (follow standard Pb free soldering guidelines)	–	260	°C

Thermal Consideration

Package	θ_{JA} , 4 Layer Board (°C/W)	θ_{JA} , 2 Layer Board (°C/W)	θ_{JC} , Bottom (°C/W)
7050	191	263	30
5032	97	199	24
3225	109	212	27
2520	117	222	26

Environmental Compliance

Parameter	Condition/Test Method
Mechanical Shock	MIL-STD-883F, Method 2002
Mechanical Vibration	MIL-STD-883F, Method 2007
Temperature Cycle	JESD22, Method A104
Solderability	MIL-STD-883F, Method 2003
Moisture Sensitivity Level	MSL1 @ 260°C

SiT8256

0.3 ps Jitter Oscillator for Networking



The Smart Timing Choice™

Test Circuit and Waveform

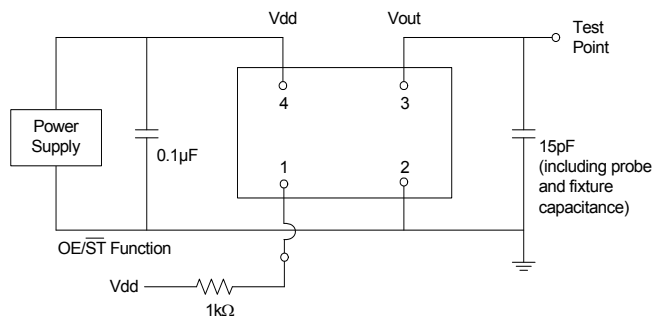

Figure 1. Test Circuit

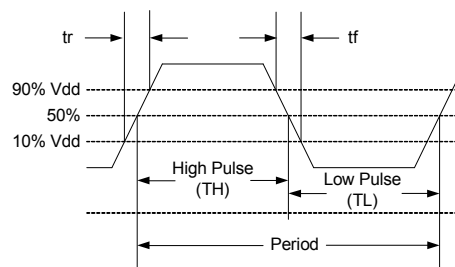

Figure 2. Waveform

Notes:

4. Duty Cycle is computed as $Duty\ Cycle = TH/Period$.
5. SiT8256 supports the configurable duty cycle feature. For custom duty cycle at any given frequency, contact [SiTime](#).

Timing Diagram

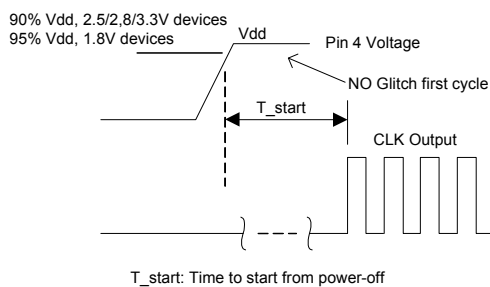

Figure 3. Startup Timing (OE/ST Mode)

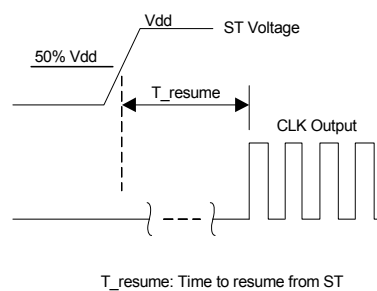

Figure 4. Standby Resume Timing (ST Mode Only)

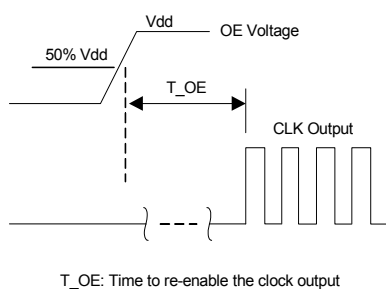

Figure 5. OE Enable Timing (OE Mode Only)

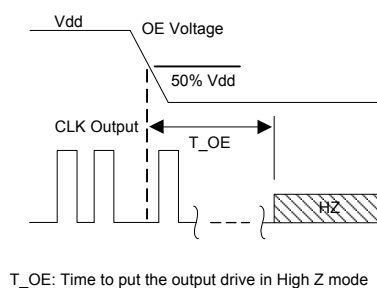

Figure 6. OE Disable Timing (OE Mode Only)

Notes:

6. SiT8256 supports no runt pulses and no glitches during startup or resume.
7. SiT8256 supports gated output which is accurate within rated frequency stability from the first cycle.

SiT8256

0.3 ps Jitter Oscillator for Networking



Dimensions and Patterns

Package Size – Dimensions (Unit: mm) ^[8]	Recommended Land Pattern (Unit: mm) ^[9]
<p>2.7 x 2.4 x 0.75 mm (100% compatible with 2.5 x 2.0 mm footprint)</p>	
<p>3.2 x 2.5 x 0.75 mm</p>	
<p>5.0 x 3.2 x 0.75 mm</p>	
<p>7.0 x 5.0 x 0.90 mm</p>	

Notes:

- 8. Top marking: Y denotes manufacturing origin and XXXX denotes manufacturing lot number. The value of “Y” will depend on the assembly location of the device.
- 9. A capacitor of value 0.1 μF between Vdd and GND is recommended.

SiT8256

0.3 ps Jitter Oscillator for Networking



Ordering Information

SiT8256AC-23-25E -156.000000T

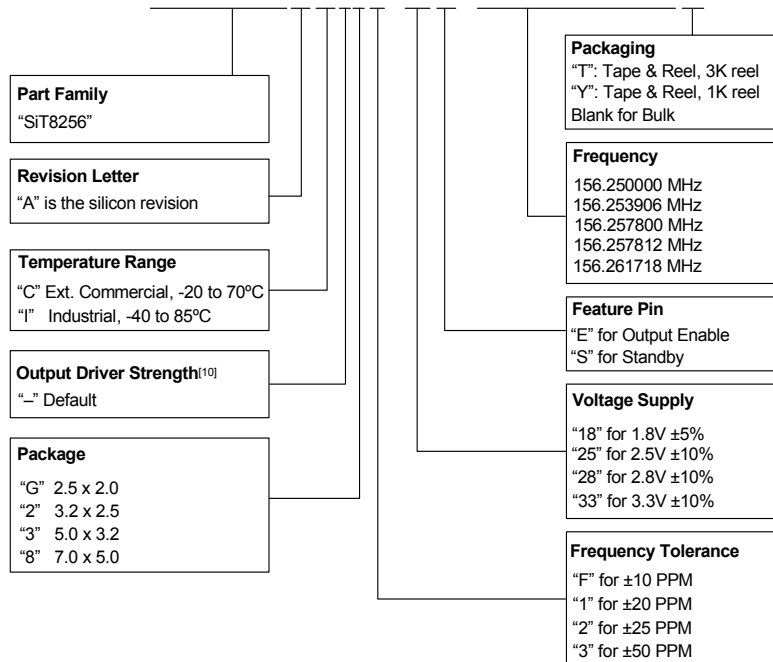

Note:

10. Contact [SiTime](#) for custom drive strength to drive higher or multiple load, or SoftEdge™ option for EMI reduction.

Additional Information

Document	Description	Download Link
Manufacturing Notes	Tape & Reel dimension, reflow profile and other manufacturing related info	http://www.sitime.com/component/docman/doc_download/85-manufacturing-notes-for-sitime-oscillators
Qualification Reports	RoHS report, reliability reports, composition reports	http://www.sitime.com/support/quality-and-reliability
Performance Reports	Additional performance data such as phase noise, current consumption and jitter for selected frequencies	http://www.sitime.com/support/performance-measurement-report
Termination Techniques	Termination design recommendations	http://www.sitime.com/support/application-notes
Layout Techniques	Layout recommendations	http://www.sitime.com/support/application-notes

© SiTime Corporation 2013. The information contained herein is subject to change at any time without notice. SiTime assumes no responsibility or liability for any loss, damage or defect of a Product which is caused in whole or in part by (i) use of any circuitry other than circuitry embodied in a SiTime product, (ii) misuse or abuse including static discharge, neglect or accident, (iii) unauthorized modification or repairs which have been soldered or altered during assembly and are not capable of being tested by SiTime under its normal test conditions, or (iv) improper installation, storage, handling, warehousing or transportation, or (v) being subjected to unusual physical, thermal, or electrical stress.

Disclaimer: SiTime makes no warranty of any kind, express or implied, with regard to this material, and specifically disclaims any and all express or implied warranties, either in fact or by operation of law, statutory or otherwise, including the implied warranties of merchantability and fitness for use or a particular purpose, and any implied warranty arising from course of dealing or usage of trade, as well as any common-law duties relating to accuracy or lack of negligence, with respect to this material, any SiTime product and any product documentation. Products sold by SiTime are not suitable or intended to be used in a life support application or component, to operate nuclear facilities, or in other mission critical applications where human life may be involved or at stake. All sales are made conditioned upon compliance with the critical uses policy set forth below.

CRITICAL USE EXCLUSION POLICY

BUYER AGREES NOT TO USE SITIME'S PRODUCTS FOR ANY APPLICATION OR IN ANY COMPONENTS USED IN LIFE SUPPORT DEVICES OR TO OPERATE NUCLEAR FACILITIES OR FOR USE IN OTHER MISSION-CRITICAL APPLICATIONS OR COMPONENTS WHERE HUMAN LIFE OR PROPERTY MAY BE AT STAKE.

SiTime owns all rights, title and interest to the intellectual property related to SiTime's products, including any software, firmware, copyright, patent, or trademark. The sale of SiTime products does not convey or imply any license under patent or other rights. SiTime retains the copyright and trademark rights in all documents, catalogs and plans supplied pursuant to or ancillary to the sale of products or services by SiTime. Unless otherwise agreed to in writing by SiTime, any reproduction, modification, translation, compilation, or representation of this material shall be strictly prohibited.



Supplemental Information

The Supplemental Information section is not part of the datasheet and is for informational purposes only.



Silicon MEMS Outperforms Quartz

Silicon MEMS Outperforms Quartz

Best Reliability

Silicon is inherently more reliable than quartz. Unlike quartz suppliers, SiTime has in-house MEMS and analog CMOS expertise, which allows SiTime to develop the most reliable products. Figure 1 shows a comparison with quartz technology.

Why is SiTime Best in Class:

- SiTime's MEMS resonators are vacuum sealed using an advanced Epi-Seal™ process, which eliminates foreign particles and improves long term aging and reliability
- World-class MEMS and CMOS design expertise

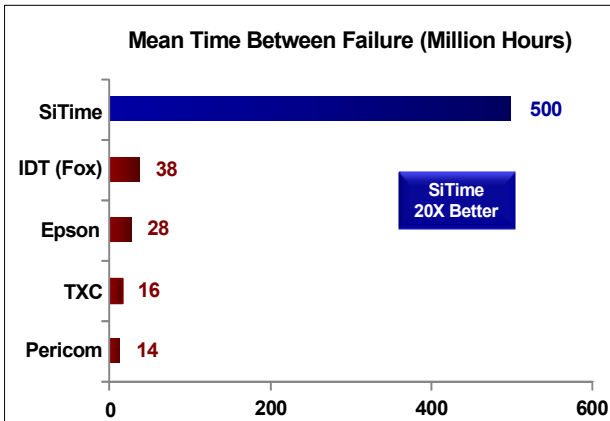

Figure 1. Reliability Comparison^[1]

Best Aging

Unlike quartz, MEMS oscillators have excellent long term aging performance which is why every new SiTime product specifies 10-year aging. A comparison is shown in Figure 2.

Why is SiTime Best in Class:

- SiTime's MEMS resonators are vacuum sealed using an advanced Epi-Seal™ process, which eliminates foreign particles and improves long term aging and reliability
- Inherently better immunity of electrostatically driven MEMS resonator

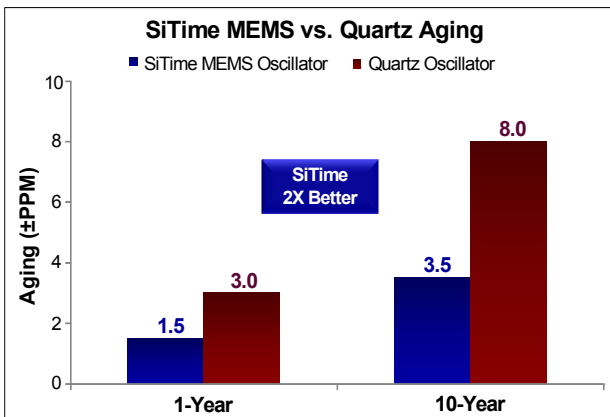

Figure 2. Aging Comparison^[2]

Best Electro Magnetic Susceptibility (EMS)

SiTime's oscillators in plastic packages are up to 54 times more immune to external electromagnetic fields than quartz oscillators as shown in Figure 3.

Why is SiTime Best in Class:

- Internal differential architecture for best common mode noise rejection
- Electrostatically driven MEMS resonator is more immune to EMS

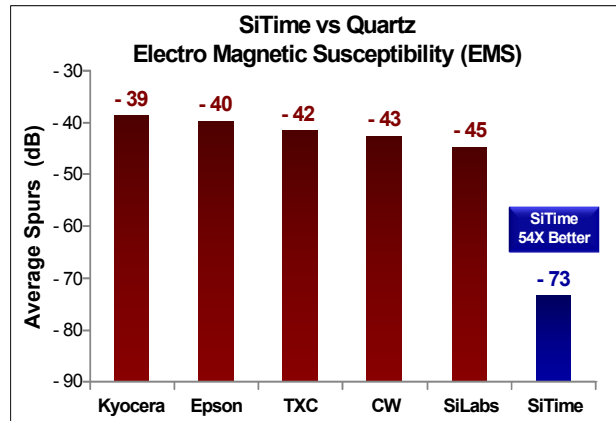

Figure 3. Electro Magnetic Susceptibility (EMS)^[3]

Best Power Supply Noise Rejection

SiTime's MEMS oscillators are more resilient against noise on the power supply. A comparison is shown in Figure 4.

Why is SiTime Best in Class:

- On-chip regulators and internal differential architecture for common mode noise rejection
- Best analog CMOS design expertise

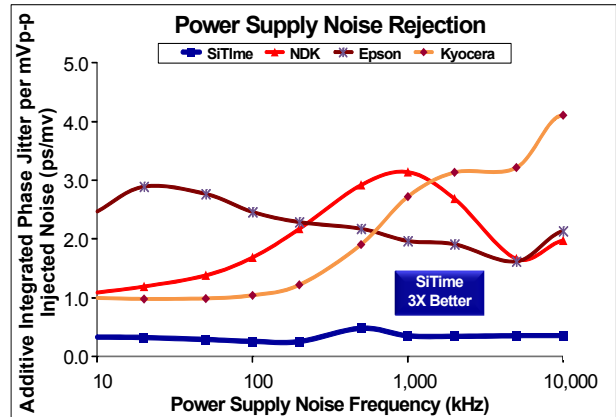

Figure 4. Power Supply Noise Rejection^[4]

Silicon MEMS Outperforms Quartz



The Smart Timing Choice™

Best Vibration Robustness

High-vibration environments are all around us. All electronics, from handheld devices to enterprise servers and storage systems are subject to vibration. Figure 5 shows a comparison of vibration robustness.

Why is SiTime Best in Class:

- The moving mass of SiTime’s MEMS resonators is up to 3000 times smaller than quartz
- Center-anchored MEMS resonator is the most robust design

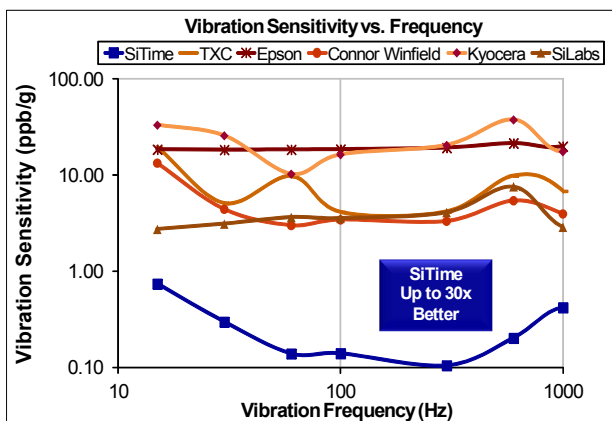

Figure 5. Vibration Robustness^[5]

Best Shock Robustness

SiTime’s oscillators can withstand at least 50,000 g shock. They all maintain their electrical performance in operation during shock events. A comparison with quartz devices is shown in Figure 6.

Why is SiTime Best in Class:

- The moving mass of SiTime’s MEMS resonators is up to 3000 times smaller than quartz
- Center-anchored MEMS resonator is the most robust design

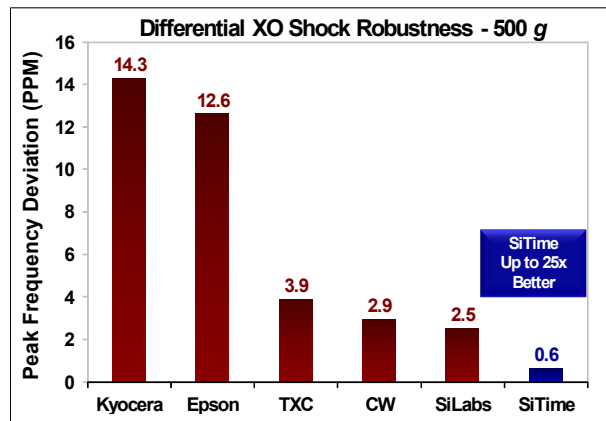

Figure 6. Shock Robustness^[6]

Notes:

1. Data Source: Reliability documents of named companies.
2. Data source: SiTime and quartz oscillator devices datasheets.
3. Test conditions for Electro Magnetic Susceptibility (EMS):
 - According to IEC EN61000-4.3 (Electromagnetic compatibility standard)
 - Field strength: 3V/m
 - Radiated signal modulation: AM 1 kHz at 80% depth
 - Carrier frequency scan: 80 MHz – 1 GHz in 1% steps
 - Antenna polarization: Vertical
 - DUT position: Center aligned to antenna
4. 50 mV pk-pk Sinusoidal voltage.

Devices used in this test:

 - SiTime, SiT9120AC-1D2-33E156.250000 - MEMS based - 156.25 MHz
 - Epson, EG-2102CA 156.2500M-PHPAL3 - SAW based - 156.25 MHz
 - TXC, BB-156.250MBE-T - 3rd Overtone quartz based - 156.25 MHz
 - Kyocera, KC7050T156.250P30E00 - SAW based - 156.25 MHz
 - Connor Winfield (CW), P123-156.25M - 3rd overtone quartz based - 156.25 MHz
 - SiLabs, Si590AB-BDG - 3rd overtone quartz based - 156.25 MHz
5. **Devices used in this test:** same as EMS test stated in Note 3.
6. Test conditions for shock test:
 - MIL-STD-883F Method 2002
 - Condition A: half sine wave shock pulse, 500-g, 1ms
 - Continuous frequency measurement in 100 μs gate time for 10 seconds

Devices used in this test: same as EMS test stated in Note 3
7. Additional data, including setup and detailed results, is available upon request to qualified customers. Please contact productsupport@sitime.com.



The Smart Timing Choice™

Document Feedback Form

SiTime values your input in improving our documentation. Click [here](#) for our online feedback form or fill out and email the form below to productsupport@sitime.com

1. Does the Electrical Characteristics table provide complete information? Yes No

If No, what parameters are missing?

2. Is the organization of this document easy to follow? Yes No

If "No," please suggest improvements that we can make:

3. Is there any application specific information that you would like to see in this document? (Check all that apply)

EMI Termination recommendations Shock and vibration performance Other

If "Other," please specify:

4. Are there any errors in this document? Yes No

If "Yes", please specify (what and where):

5. Do you have additional recommendations for this document?

Name _____

Title _____

Company _____

Address _____

City / State or Province / Postal Code / Country _____

Telephone _____

Application _____

Would you like a reply? Yes No

Thank you for your feedback. Please click the email icon in your Adobe Reader tool bar and send to productsupport@sitime.com. Or you may use our [online feedback form](#).