

SiT8920B

-55°C to +125°C Oscillator



Features

- Frequencies between 1 MHz and 110 MHz accurate to 6 decimal places
- Operating temperature from -55°C to 125°C
- Supply voltage of 1.8V or 2.5V to 3.3V
- Excellent total frequency stability as low as ± 20 ppm
- Low power consumption of 3.5 mA typical at 1.8V
- LVCMOS/LVTTL compatible output
- Industry-standard packages: 2.0 x 1.6, 2.5 x 2.0, 3.2 x 2.5, 5.0 x 3.2, 7.0 x 5.0 mm x mm
- Instant samples with [Time Machine II](#) and [field programmable oscillators](#)
- RoHS and REACH compliant, Pb-free, Halogen-free and Antimony-free

Applications

- Ruggedized equipment in harsh operating environment

INSTANT
SAMPLESGREEN
SOLUTIONSLIFETIME
WARRANTY

Electrical Specifications

Table 1. Electrical Characteristics

All Min and Max limits are specified over temperature and rated operating voltage with 15 pF output load unless otherwise stated. Typical values are at 25°C and nominal supply voltage.

| Parameters | Symbol | Min. | Typ. | Max. | Unit | Condition |
|---|--------|------|------|------|---------|---|
| Frequency Range | | | | | | |
| Output Frequency Range | f | 1 | – | 110 | MHz | Refer to Table 13 for the exact list of supported frequencies list of supported frequencies |
| Frequency Stability and Aging | | | | | | |
| Frequency Stability | F_stab | -20 | – | +20 | ppm | Inclusive of Initial tolerance at 25°C, 1st year aging at 25°C, and variations over operating temperature, rated power supply voltage and load (15 pF \pm 10%). |
| | | -25 | – | +25 | ppm | |
| | | -30 | – | +30 | ppm | |
| | | -50 | – | +50 | ppm | |
| Operating Temperature Range | | | | | | |
| Operating Temperature Range | T_use | -55 | – | +125 | °C | |
| Supply Voltage and Current Consumption | | | | | | |
| Supply Voltage | Vdd | 1.62 | 1.8 | 1.98 | V | |
| | | 2.25 | 2.5 | 2.75 | V | |
| | | 2.52 | 2.8 | 3.08 | V | |
| | | 2.7 | 3.0 | 3.3 | V | |
| | | 2.97 | 3.3 | 3.63 | V | |
| | | 2.25 | – | 3.63 | V | |
| Current Consumption | Idd | – | 3.8 | 4.7 | mA | No load condition, f = 20 MHz, Vdd = 2.8V, 3.0V or 3.3V |
| | | – | 3.6 | 4.5 | mA | No load condition, f = 20 MHz, Vdd = 2.5V |
| | | – | 3.5 | 4.5 | mA | No load condition, f = 20 MHz, Vdd = 1.8V |
| OE Disable Current | I_od | – | – | 4.5 | mA | Vdd = 2.5V to 3.3V, OE = Low, Output in high Z state. |
| | | – | – | 4.3 | mA | Vdd = 1.8V, OE = Low, Output in high Z state. |
| Standby Current | I_std | – | 2.6 | 8.5 | μ A | Vdd = 2.8V to 3.3V, \overline{ST} = Low, Output is weakly pulled down |
| | | – | 1.4 | 5.5 | μ A | Vdd = 2.5V, \overline{ST} = Low, Output is weakly pulled down |
| | | – | 0.6 | 4.0 | μ A | Vdd = 1.8V, \overline{ST} = Low, Output is weakly pulled down |
| LVCMOS Output Characteristics | | | | | | |
| Duty Cycle | DC | 45 | – | 55 | % | All Vdds |
| Rise/Fall Time | Tr, Tf | – | 1.0 | 2.0 | ns | Vdd = 2.5V, 2.8V, 3.0V or 3.3V, 20% - 80% |
| | | – | 1.3 | 2.5 | ns | Vdd = 1.8V, 20% - 80% |
| | | – | 1.0 | 3 | ns | Vdd = 2.25V - 3.63V, 20% - 80% |
| Output High Voltage | VOH | 90% | – | – | Vdd | IOH = -4 mA (Vdd = 3.0V or 3.3V) IOH = -3 mA (Vdd = 2.8V or 2.5V) IOH = -2 mA (Vdd = 1.8V) |
| Output Low Voltage | VOL | – | – | 10% | Vdd | IOL = 4 mA (Vdd = 3.0V or 3.3V) IOL = 3 mA (Vdd = 2.8V or 2.5V) IOL = 2 mA (Vdd = 1.8V) |

SiT8920B

-55°C to +125°C Oscillator

Table 1. Electrical Characteristics (continued)

| Parameters | Symbol | Min. | Typ. | Max. | Unit | Condition |
|----------------------------------|---------------------|------|------|------|-----------------|--|
| Input Characteristics | | | | | | |
| Input High Voltage | V _{IH} | 70% | – | – | V _{dd} | Pin 1, OE or \overline{ST} |
| Input Low Voltage | V _{IL} | – | – | 30% | V _{dd} | Pin 1, OE or \overline{ST} |
| Input Pull-up Impedance | Z _{in} | 50 | 87 | 150 | kΩ | Pin 1, OE logic high or logic low, or \overline{ST} logic high |
| | | 2 | – | – | MΩ | Pin 1, \overline{ST} logic low |
| Startup and Resume Timing | | | | | | |
| Startup Time | T _{start} | – | – | 5 | ms | Measured from the time V _{dd} reaches its rated minimum value |
| Enable/Disable Time | T _{oe} | – | – | 130 | ns | f = 110 MHz. For other frequencies, T _{oe} = 100 ns + 3 * clock periods |
| Resume Time | T _{resume} | – | – | 5 | ms | Measured from the time ST pin crosses 50% threshold |
| Jitter | | | | | | |
| RMS Period Jitter | T _{jitt} | – | 1.6 | 2.5 | ps | f = 75MHz, V _{dd} = 2.5V, 2.8V, 3.0V or 3.3V |
| | | – | 1.9 | 3 | ps | f = 75MHz, V _{dd} = 1.8V |
| Peak-to-peak Period Jitter | T _{pk} | – | 12 | 20 | ps | f = 75MHz, V _{dd} = 2.5V, 2.8V, 3.0V or 3.3V |
| | | – | 14 | 25 | ps | f = 75MHz, V _{dd} = 1.8V |
| RMS Phase Jitter (random) | T _{phj} | – | 0.5 | 0.8 | ps | f = 75MHz, Integration bandwidth = 900 kHz to 7.5 MHz |
| | | – | 1.3 | 2 | ps | f = 75MHz, Integration bandwidth = 12 kHz to 20 MHz |

Table 2. Pin Description

| Pin | Symbol | | Functionality |
|-----|-------------------------|---------------|---|
| 1 | OE/ \overline{ST} /NC | Output Enable | H ^[1] : specified frequency output L: output is high impedance. Only output driver is disabled. |
| | | Standby | H ^[1] : specified frequency output L: output is low (weak pull down). Device goes to sleep mode. Supply current reduces to I _{std} . |
| | | No Connect | Any voltage between 0 and V _{dd} or Open ^[1] : Specified frequency output. Pin 1 has no function. |
| 2 | GND | Power | Electrical ground |
| 3 | OUT | Output | Oscillator output |
| 4 | VDD | Power | Power supply voltage ^[2] |

Notes:

- In OE or \overline{ST} mode, a pull-up resistor of 10kΩ or less is recommended if pin 1 is not externally driven. If pin 1 needs to be left floating, use the NC option.
- A capacitor of value 0.1 μF or higher between V_{dd} and GND is required.

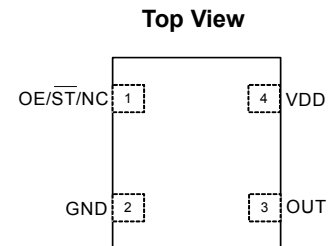
Figure 1. Pin Assignments

SiT8920B

-55°C to +125°C Oscillator



The Smart Timing Choice™

Table 3. Absolute Maximum Limits

Attempted operation outside the absolute maximum ratings of the part may cause permanent damage to the part. Actual performance of the IC is only guaranteed within the operational specifications, not at absolute maximum ratings.

| Parameter | Min. | Max. | Unit |
|--|------|------|------|
| Storage Temperature | -65 | 150 | °C |
| Vdd | -0.5 | 4 | V |
| Electrostatic Discharge | – | 2000 | V |
| Soldering Temperature (follow standard Pb free soldering guidelines) | – | 260 | °C |
| Junction Temperature ^[3] | – | 150 | °C |

Note:

3. Exceeding this temperature for extended period of time may damage the device.

Table 4. Thermal Consideration^[4]

| Package | θ_{JA} , 4 Layer Board (°C/W) | θ_{JA} , 2 Layer Board (°C/W) | θ_{JC} , Bottom (°C/W) |
|---------|--------------------------------------|--------------------------------------|-------------------------------|
| 7050 | 142 | 273 | 30 |
| 5032 | 97 | 199 | 24 |
| 3225 | 109 | 212 | 27 |
| 2520 | 117 | 222 | 26 |
| 2016 | 152 | 252 | 36 |

Note:

4. Refer to JESD51-7 for θ_{JA} and θ_{JC} definitions, and reference layout used to determine the θ_{JA} and θ_{JC} values in the above table.

Table 5. Maximum Operating Junction Temperature^[5]

| Max Operating Temperature (ambient) | Maximum Operating Junction Temperature |
|-------------------------------------|--|
| 125°C | 135°C |

Note:

5. Datasheet specifications are not guaranteed if junction temperature exceeds the maximum operating junction temperature.

Table 6. Environmental Compliance

| Parameter | Condition/Test Method |
|----------------------------|---------------------------|
| Mechanical Shock | MIL-STD-883F, Method 2002 |
| Mechanical Vibration | MIL-STD-883F, Method 2007 |
| Temperature Cycle | JESD22, Method A104 |
| Solderability | MIL-STD-883F, Method 2003 |
| Moisture Sensitivity Level | MSL1 @ 260°C |

SiT8920B

-55°C to +125°C Oscillator



Test Circuit and Waveform^[6]

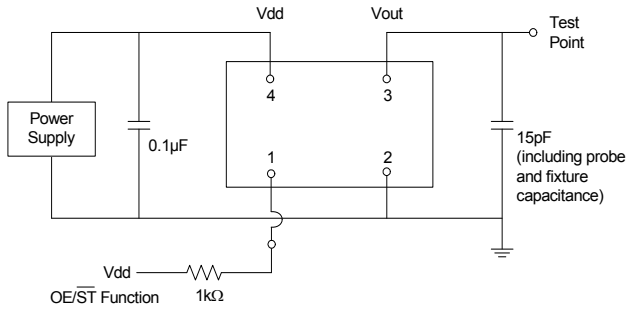

Figure 2. Test Circuit

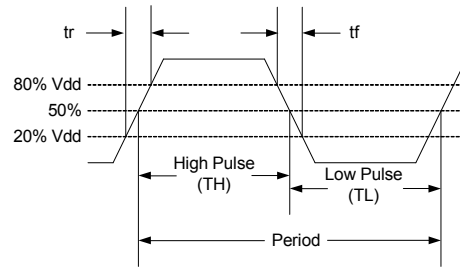
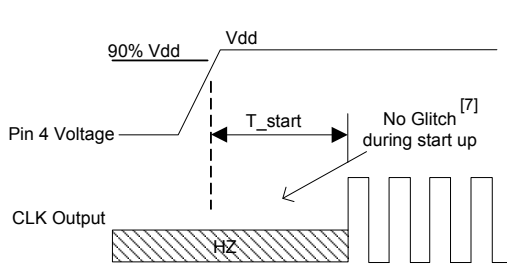

Figure 3. Waveform

Note:

6. Duty Cycle is computed as $Duty\ Cycle = TH/Period$.

Timing Diagrams



T_start: Time to start from power-off

Figure 4. Startup Timing (OE/ST Mode)

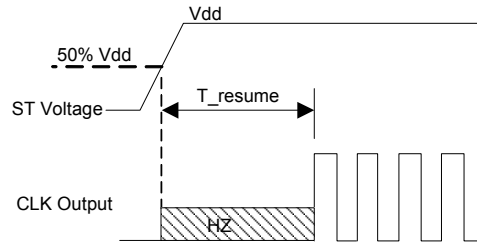

T_resume: Time to resume from ST

Figure 5. Standby Resume Timing (ST Mode Only)

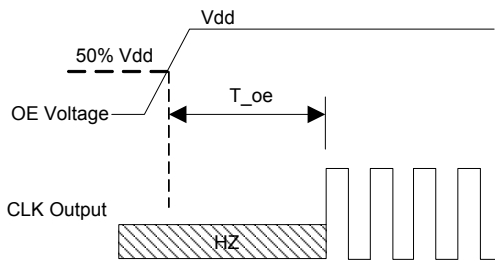

T_oe: Time to re-enable the clock output

Figure 6. OE Enable Timing (OE Mode Only)

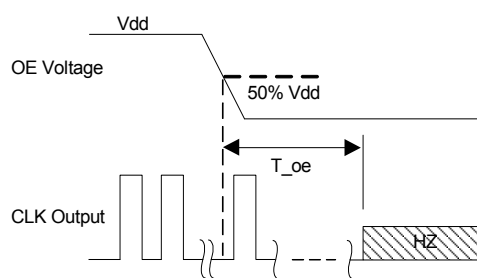

T_oe: Time to put the output in High Z mode

Figure 7. OE Disable Timing (OE Mode Only)

Note:

7. SiT8920 has "no runt" pulses and "no glitch" output during startup or resume.

SiT8920B

-55°C to +125°C Oscillator



The Smart Timing Choice™

Performance Plots^[8]

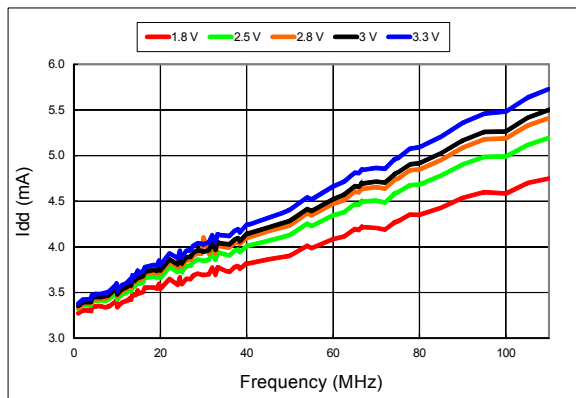

Figure 8. Idd vs Frequency

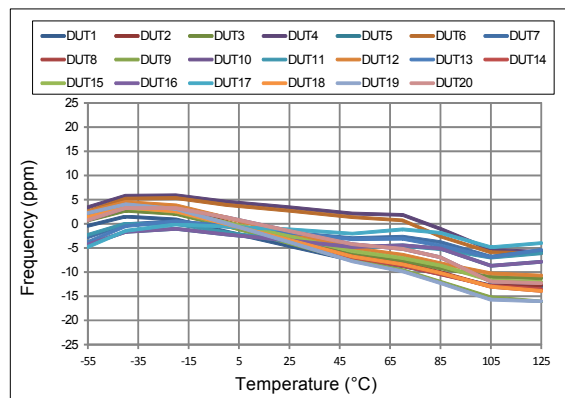

Figure 9. Frequency vs Temperature

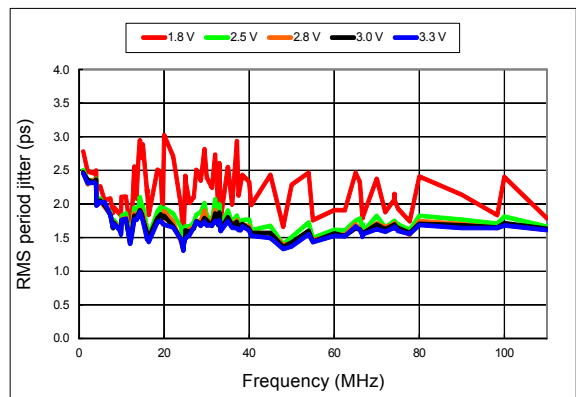

Figure 10. RMS Period Jitter vs Frequency

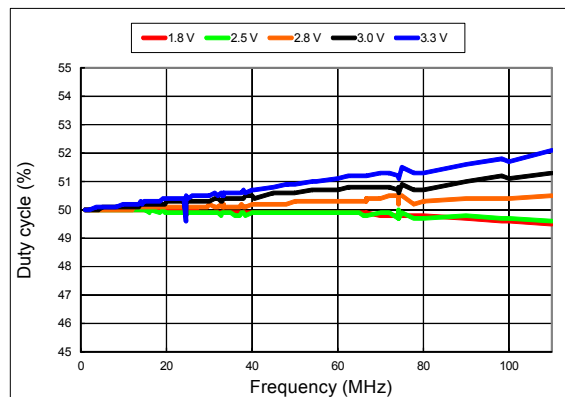

Figure 11. Duty Cycle vs Frequency

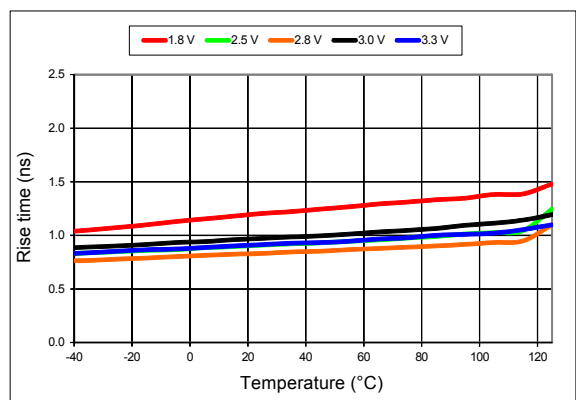

Figure 12. 20%-80% Rise Time vs Temperature

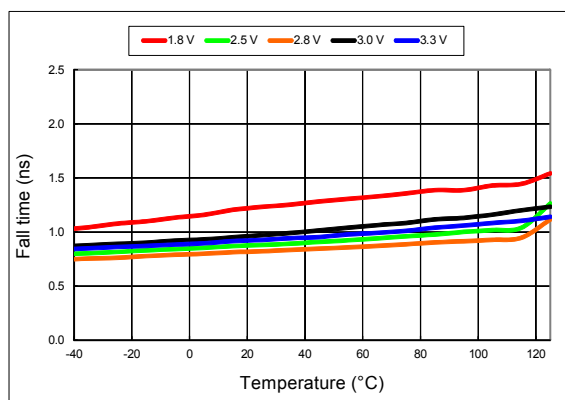

Figure 13. 20%-80% Fall Time vs Temperature

SiT8920B

-55°C to +125°C Oscillator



The Smart Timing Choice™

Performance Plots^[8]

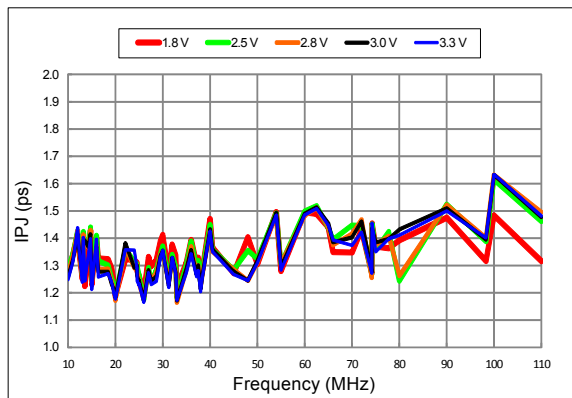

Figure 14. RMS Integrated Phase Jitter Random (12k to 20 MHz) vs Frequency^[9]

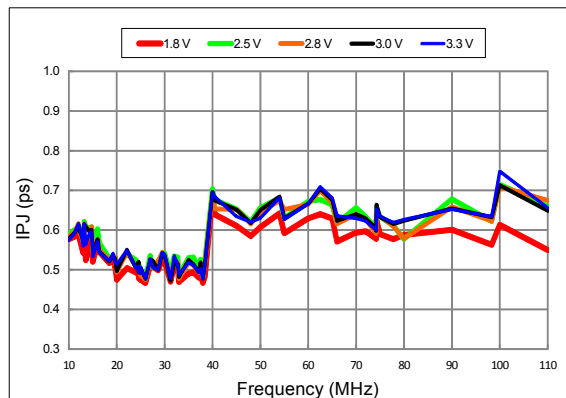

Figure 15. RMS Integrated Phase Jitter Random (900 kHz to 20 MHz) vs Frequency^[9]

Notes:

- 8. All plots are measured with 15 pF load at room temperature, unless otherwise stated.
- 9. Phase noise plots are measured with Agilent E5052B signal source analyzer. Integration range is 12 kHz to 5 MHz for carrier frequencies up to 40 MHz.

SiT8920B

-55°C to +125°C Oscillator



Programmable Drive Strength

The SiT8920 includes a programmable drive strength feature to provide a simple, flexible tool to optimize the clock rise/fall time for specific applications. Benefits from the programmable drive strength feature are:

- Improves system radiated electromagnetic interference (EMI) by slowing down the clock rise/fall time
- Improves the downstream clock receiver's (RX) jitter by decreasing (speeding up) the clock rise/fall time.
- Ability to drive large capacitive loads while maintaining full swing with sharp edge rates.

For more detailed information about rise/fall time control and drive strength selection, see the SiTime Applications Note section; <http://www.sitime.com/support/application-notes>.

EMI Reduction by Slowing Rise/Fall Time

Figure 16 shows the harmonic power reduction as the rise/fall times are increased (slowed down). The rise/fall times are expressed as a ratio of the clock period. For the ratio of 0.05, the signal is very close to a square wave. For the ratio of 0.45, the rise/fall times are very close to near-triangular waveform. These results, for example, show that the 11th clock harmonic can be reduced by 35 dB if the rise/fall edge is increased from 5% of the period to 45% of the period.

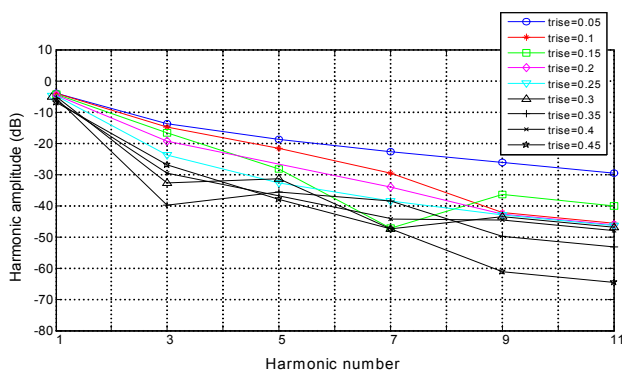

Figure 16. Harmonic EMI reduction as a Function of Slower Rise/Fall Time

Jitter Reduction with Faster Rise/Fall Time

Power supply noise can be a source of jitter for the downstream chipset. One way to reduce this jitter is to speed up the rise/fall time of the input clock. Some chipsets may also require faster rise/fall time in order to reduce their sensitivity to this type of jitter. Refer to the [Rise/Fall Time Tables \(Table 7 to Table 11\)](#) to determine the proper drive strength.

High Output Load Capability

The rise/fall time of the input clock varies as a function of the actual capacitive load the clock drives. At any given drive strength, the rise/fall time becomes slower as the output load increases. As an example, for a 3.3V SiT8920 device with default drive strength setting, the typical rise/fall time is 1ns for 15 pF output load. The typical rise/fall time slows down to 2.6ns when the output load increases to 45 pF. One can choose to speed up the rise/fall time to 1.83ns by then increasing the drive strength setting on the SiT8920.

The SiT8920 can support up to 60 pF or higher in maximum capacitive loads with drive strength settings. Refer to the [Rise/Fall Time Tables \(Table 7 to 11\)](#) to determine the proper drive strength for the desired combination of output load vs. rise/fall time

SiT8920 Drive Strength Selection

Tables 7 through 11 define the rise/fall time for a given capacitive load and supply voltage.

1. Select the table that matches the SiT8920 nominal supply voltage (1.8V, 2.5V, 2.8V, 3.0V, 3.3V).
2. Select the capacitive load column that matches the application requirement (5 pF to 60 pF)
3. Under the capacitive load column, select the desired rise/fall times.
4. The left-most column represents the part number code for the corresponding drive strength.
5. Add the drive strength code to the part number for ordering purposes.

Calculating Maximum Frequency

Based on the rise and fall time data given in Tables 7 through 11, the maximum frequency the oscillator can operate with guaranteed full swing of the output voltage over temperature as follows:

$$\text{Max Frequency} = \frac{1}{5 \times \text{Trf}_{20/80}}$$

where $\text{Trf}_{20/80}$ is the typical value for 20%-80% rise/fall time.

Example 1

Calculate f_{MAX} for the following condition:

- Vdd = 1.8V (Table 7)
- Capacitive Load: 30 pF
- Desired Tr/f time = 3 ns (rise/fall time part number code = E)

Part number for the above example:

SiT8920BME12-18E-66.666660



Drive strength code is inserted here. Default setting is “-”

SiT8920B

-55°C to +125°C Oscillator



Rise/Fall Time (20% to 80%) vs C_{LOAD} Tables

Table 7. V_{DD} = 1.8V Rise/Fall Times for Specific C_{LOAD}

| Rise/Fall Time Typ (ns) | | | | | |
|------------------------------------|------|-------|-------|-------|-------|
| Drive Strength \ C _{LOAD} | 5 pF | 15 pF | 30 pF | 45 pF | 60 pF |
| L | 6.16 | 11.61 | 22.00 | 31.27 | 39.91 |
| A | 3.19 | 6.35 | 11.00 | 16.01 | 21.52 |
| R | 2.11 | 4.31 | 7.65 | 10.77 | 14.47 |
| B | 1.65 | 3.23 | 5.79 | 8.18 | 11.08 |
| T | 0.93 | 1.91 | 3.32 | 4.66 | 6.48 |
| E | 0.78 | 1.66 | 2.94 | 4.09 | 5.74 |
| U | 0.70 | 1.48 | 2.64 | 3.68 | 5.09 |
| F or "-": default | 0.65 | 1.30 | 2.40 | 3.35 | 4.56 |

Table 8. V_{DD} = 2.5V Rise/Fall Times for Specific C_{LOAD}

| Rise/Fall Time Typ (ns) | | | | | |
|------------------------------------|------|-------|-------|-------|-------|
| Drive Strength \ C _{LOAD} | 5 pF | 15 pF | 30 pF | 45 pF | 60 pF |
| L | 4.13 | 8.25 | 12.82 | 21.45 | 27.79 |
| A | 2.11 | 4.27 | 7.64 | 11.20 | 14.49 |
| R | 1.45 | 2.81 | 5.16 | 7.65 | 9.88 |
| B | 1.09 | 2.20 | 3.88 | 5.86 | 7.57 |
| T | 0.62 | 1.28 | 2.27 | 3.51 | 4.45 |
| E or "-": default | 0.54 | 1.00 | 2.01 | 3.10 | 4.01 |
| U | 0.43 | 0.96 | 1.81 | 2.79 | 3.65 |
| F | 0.34 | 0.88 | 1.64 | 2.54 | 3.32 |

Table 9. V_{DD} = 2.8V Rise/Fall Times for Specific C_{LOAD}

| Rise/Fall Time Typ (ns) | | | | | |
|------------------------------------|------|-------|-------|-------|-------|
| Drive Strength \ C _{LOAD} | 5 pF | 15 pF | 30 pF | 45 pF | 60 pF |
| L | 3.77 | 7.54 | 12.28 | 19.57 | 25.27 |
| A | 1.94 | 3.90 | 7.03 | 10.24 | 13.34 |
| R | 1.29 | 2.57 | 4.72 | 7.01 | 9.06 |
| B | 0.97 | 2.00 | 3.54 | 5.43 | 6.93 |
| T | 0.55 | 1.12 | 2.08 | 3.22 | 4.08 |
| E or "-": default | 0.44 | 1.00 | 1.83 | 2.82 | 3.67 |
| U | 0.34 | 0.88 | 1.64 | 2.52 | 3.30 |
| F | 0.29 | 0.81 | 1.48 | 2.29 | 2.99 |

Table 10. V_{DD} = 3.0V Rise/Fall Times for Specific C_{LOAD}

| Rise/Fall Time Typ (ns) | | | | | |
|------------------------------------|------|-------|-------|-------|-------|
| Drive Strength \ C _{LOAD} | 5 pF | 15 pF | 30 pF | 45 pF | 60 pF |
| L | 3.60 | 7.21 | 11.97 | 18.74 | 24.30 |
| A | 1.84 | 3.71 | 6.72 | 9.86 | 12.68 |
| R | 1.22 | 2.46 | 4.54 | 6.76 | 8.62 |
| B | 0.89 | 1.92 | 3.39 | 5.20 | 6.64 |
| T or "-": default | 0.51 | 1.00 | 1.97 | 3.07 | 3.90 |
| E | 0.38 | 0.92 | 1.72 | 2.71 | 3.51 |
| U | 0.30 | 0.83 | 1.55 | 2.40 | 3.13 |
| F | 0.27 | 0.76 | 1.39 | 2.16 | 2.85 |

Table 11. V_{DD} = 3.3V Rise/Fall Times for Specific C_{LOAD}

| Rise/Fall Time Typ (ns) | | | | | |
|------------------------------------|------|-------|-------|-------|-------|
| Drive Strength \ C _{LOAD} | 5 pF | 15 pF | 30 pF | 45 pF | 60 pF |
| L | 3.39 | 6.88 | 11.63 | 17.56 | 23.59 |
| A | 1.74 | 3.50 | 6.38 | 8.98 | 12.19 |
| R | 1.16 | 2.33 | 4.29 | 6.04 | 8.34 |
| B | 0.81 | 1.82 | 3.22 | 4.52 | 6.33 |
| T or "-": default | 0.46 | 1.00 | 1.86 | 2.60 | 3.84 |
| E | 0.33 | 0.87 | 1.64 | 2.30 | 3.35 |
| U | 0.28 | 0.79 | 1.46 | 2.05 | 2.93 |
| F | 0.25 | 0.72 | 1.31 | 1.83 | 2.61 |

SiT8920B

-55°C to +125°C Oscillator



Pin 1 Configuration Options (OE, $\overline{\text{ST}}$, or NC)

Pin 1 of the SiT8920 can be factory-programmed to support three modes: Output enable (OE), standby ($\overline{\text{ST}}$) or No Connect (NC). These modes can also be programmed with the Time Machine using field programmable devices.

Output Enable (OE) Mode

In the OE mode, applying logic Low to the OE pin only disables the output driver and puts it in Hi-Z mode. The core of the device continues to operate normally. Power consumption is reduced due to the inactivity of the output. When the OE pin is pulled High, the output is typically enabled in $<1\mu\text{s}$.

Standby ($\overline{\text{ST}}$) Mode

In the $\overline{\text{ST}}$ mode, a device enters into the standby mode when Pin 1 pulled Low. All internal circuits of the device are turned off. The current is reduced to a standby current, typically in the range of a few μA . When $\overline{\text{ST}}$ is pulled High, the device goes through the “resume” process, which can take up to 5 ms.

No Connect (NC) Mode

In the NC mode, the device always operates in its normal mode and output the specified frequency regardless of the logic level on pin 1.

Table 12 below summarizes the key relevant parameters in the operation of the device in OE, $\overline{\text{ST}}$, or NC mode.

Table 12. OE vs. $\overline{\text{ST}}$ vs. NC

| | OE | $\overline{\text{ST}}$ | NC |
|---|--------|------------------------|--------|
| Active current 20 MHz (max, 1.8V) | 4.5 mA | 4.5 mA | 4.5 mA |
| OE disable current (max, 1.8V) | 4.3 mA | N/A | N/A |
| Standby current (typical 1.8V) | N/A | 0.6 μA | N/A |
| OE enable time at 110 MHz (max) | 130 ns | N/A | N/A |
| Resume time from standby (max, all frequency) | N/A | 5 ms | N/A |
| Output driver in OE disable/standby mode | High Z | weak pull-down | N/A |

Output on Startup and Resume

The SiT8920 comes with gated output. Its clock output is accurate to the rated frequency stability within the first pulse from initial device startup or resume from the standby mode.

In addition, the SiT8920 has NO RUNT, NO GLITCH output during startup or resume as shown in the waveform captures in Figure 17 and Figure 18.



Figure 17. Startup Waveform vs. Vdd

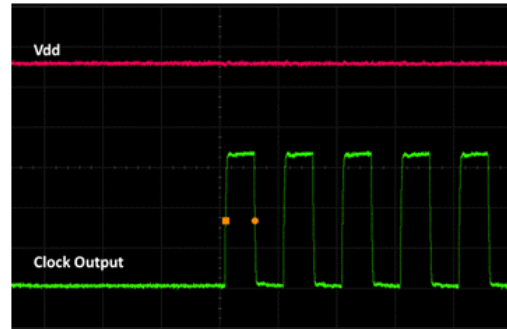

Figure 18. Startup Waveform vs. Vdd (Zoomed-in View of Figure 17)

Instant Samples with Time Machine and Field Programmable Oscillators

SiTime supports a field programmable version of the [SiT8920 high temperature oscillator](#) for fast prototyping and real time customization of features. The [field programmable devices](#) (FP devices) are available for all five standard SiT8920 package sizes and can be configured to one's exact specification using the [Time Machine II](#), an USB powered MEMS oscillator programmer.

Customizable Features of the SiT8920 FP Devices Include

- Frequencies between 1 – 110 MHz
- Four frequency stability options, ± 20 ppm, ± 25 ppm, ± 30 ppm, ± 50 ppm
- Six supply voltage options, 1.8V, 2.5V, 2.8V, 3.0V, 3.3V and 2.25 to 3.63V continuous
- Output drive strength

For more information regarding SiTime's field programmable solutions, visit <http://www.sitime.com/time-machine> and <http://www.sitime.com/fp-devices>.

SiT8920 is factory-programmed per customer ordering codes for volume delivery.

SiT8920B

-55°C to +125°C Oscillator



Dimensions and Patterns

| Package Size – Dimensions (Unit: mm) ^[10] | Recommended Land Pattern (Unit: mm) ^[11] |
|--|---|
| <p>2.0 x 1.6 x 0.75 mm</p> | |
| <p>2.5 x 2.0 x 0.75 mm</p> | |
| <p>3.2 x 2.5 x 0.75 mm</p> | |
| <p>5.0 x 3.2 x 0.75 mm</p> | |

SiT8920B

-55°C to +125°C Oscillator



Dimensions and Patterns

| Package Size – Dimensions (Unit: mm) ^[10] | Recommended Land Pattern (Unit: mm) ^[11] |
|--|---|
| <p>7.0 x 5.0 x 0.90 mm</p> | |

Notes:

10. Top marking: Y denotes manufacturing origin and XXXX denotes manufacturing lot number. The value of “Y” will depend on the assembly location of the device.
11. A capacitor of value 0.1 μ F or higher between Vdd and GND is required.

SiT8920B

-55°C to +125°C Oscillator



The Smart Timing Choice™

Ordering Information

The Part No. Guide is for reference only. To customize and build an exact part number, use the SiTime [Part Number Generator](#).

SiT8920BM-12-18E -25.000625D

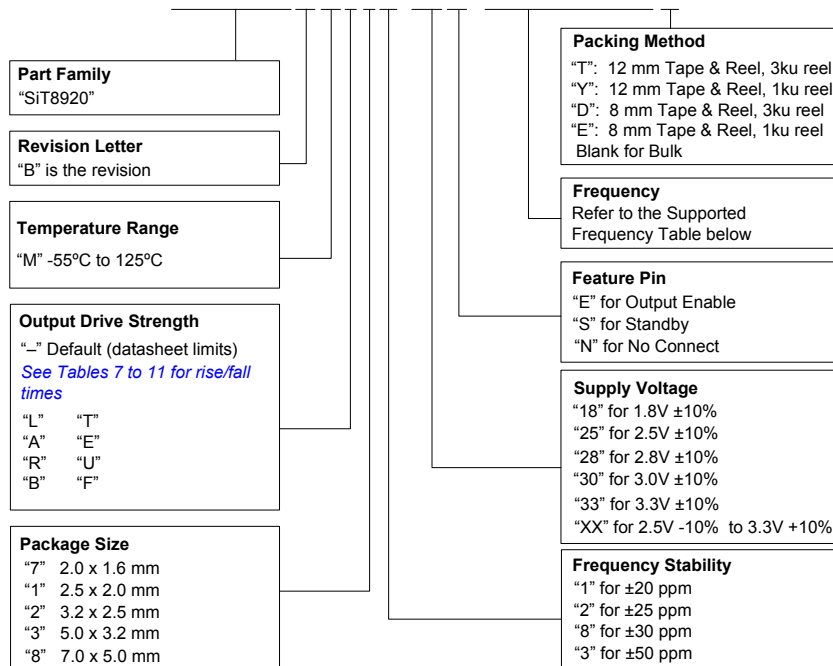

Table 13. List of Supported Frequencies^[12, 13]

| Frequency Range (-55 to +125°C) | |
|------------------------------------|----------------|
| Min. | Max. |
| 1.000000 MHz | 61.222999 MHz |
| 61.674001 MHz | 69.239999 MHz |
| 70.827001 MHz | 78.714999 MHz |
| 79.561001 MHz | 80.159999 MHz |
| 80.174001 MHz | 80.779999 MHz |
| 82.632001 MHz | 91.833999 MHz |
| 95.474001 MHz | 96.191999 MHz |
| 96.209001 MHz | 96.935999 MHz |
| 99.158001 MHz | 110.000000 MHz |

Notes:

- 12. Any frequency within the min and max values in the above table are supported with 6 decimal places of accuracy.
- 13. Please contact [SiTime](#) for frequencies that are not listed in the tables above.

Table 14. Ordering Codes for Supported Tape & Reel Packing Method

| Device Size (mm x mm) | 16 mm T&R (3ku) | 16 mm T&R (1ku) | 12 mm T&R (3ku) | 12 mm T&R (1ku) | 8 mm T&R (3ku) | 8 mm T&R (1ku) |
|--------------------------|-----------------|-----------------|-----------------|-----------------|----------------|----------------|
| 2.0 x 1.6 | - | - | - | - | D | E |
| 2.5 x 2.0 | - | - | - | - | D | E |
| 3.2 x 2.5 | - | - | - | - | D | E |
| 5.0 x 3.2 | - | - | T | Y | - | - |
| 7.0 x 5.0 | T | Y | - | - | - | - |

SiT8920B

-55°C to +125°C Oscillator



Table 15. Additional Information

| Document | Description | Download Link |
|--------------------------------|--|---|
| Time Machine II | MEMS oscillator programmer | http://www.sitime.com/support/time-machine-oscillator-programmer |
| Field Programmable Oscillators | Devices that can be programmable in the field by Time Machine II | http://www.sitime.com/products/field-programmable-oscillators |
| Manufacturing Notes | Tape & Reel dimension, reflow profile and other manufacturing related info | http://www.sitime.com/component/docman/doc_download/243-manufacturing-notes-for-sitime-oscillators |
| Qualification Reports | RoHS report, reliability reports, composition reports | http://www.sitime.com/support/quality-and-reliability |
| Performance Reports | Additional performance data such as phase noise, current consumption and jitter for selected frequencies | http://www.sitime.com/support/performance-measurement-report |
| Termination Techniques | Termination design recommendations | http://www.sitime.com/support/application-notes |
| Layout Techniques | Layout recommendations | http://www.sitime.com/support/application-notes |

Revision History

Table 16. Datasheet Version and Change Log

| Version | Release Date | Change Summary |
|---------|--------------|--|
| 1.0 | 5/7/15 | Final production release |
| 1.01 | 6/18/15 | <ul style="list-style-type: none"> Added 16 mm T&R information to Table 14 Revised 12 mm T&R information to Table 14 |

© SiTime Corporation 2015. The information contained herein is subject to change at any time without notice. SiTime assumes no responsibility or liability for any loss, damage or defect of a Product which is caused in whole or in part by (i) use of any circuitry other than circuitry embodied in a SiTime product, (ii) misuse or abuse including static discharge, neglect or accident, (iii) unauthorized modification or repairs which have been soldered or altered during assembly and are not capable of being tested by SiTime under its normal test conditions, or (iv) improper installation, storage, handling, warehousing or transportation, or (v) being subjected to unusual physical, thermal, or electrical stress.

Disclaimer: SiTime makes no warranty of any kind, express or implied, with regard to this material, and specifically disclaims any and all express or implied warranties, either in fact or by operation of law, statutory or otherwise, including the implied warranties of merchantability and fitness for use or a particular purpose, and any implied warranty arising from course of dealing or usage of trade, as well as any common-law duties relating to accuracy or lack of negligence, with respect to this material, any SiTime product and any product documentation. Products sold by SiTime are not suitable or intended to be used in a life support application or component, to operate nuclear facilities, or in other mission critical applications where human life may be involved or at stake. All sales are made conditioned upon compliance with the critical uses policy set forth below.

CRITICAL USE EXCLUSION POLICY

BUYER AGREES NOT TO USE SITIME'S PRODUCTS FOR ANY APPLICATION OR IN ANY COMPONENTS USED IN LIFE SUPPORT DEVICES OR TO OPERATE NUCLEAR FACILITIES OR FOR USE IN OTHER MISSION-CRITICAL APPLICATIONS OR COMPONENTS WHERE HUMAN LIFE OR PROPERTY MAY BE AT STAKE.

SiTime owns all rights, title and interest to the intellectual property related to SiTime's products, including any software, firmware, copyright, patent, or trademark. The sale of SiTime products does not convey or imply any license under patent or other rights. SiTime retains the copyright and trademark rights in all documents, catalogs and plans supplied pursuant to or ancillary to the sale of products or services by SiTime. Unless otherwise agreed to in writing by SiTime, any reproduction, modification, translation, compilation, or representation of this material shall be strictly prohibited.



Supplemental Information

The Supplemental Information section is not part of the datasheet and is for informational purposes only.



Silicon MEMS Outperforms Quartz



Silicon MEMS Outperforms Quartz

Best Reliability

Silicon is inherently more reliable than quartz. Unlike quartz suppliers, SiTime has in-house MEMS and analog CMOS expertise, which allows SiTime to develop the most reliable products. Figure 1 shows a comparison with quartz technology.

Why is SiTime Best in Class:

- SiTime's MEMS resonators are vacuum sealed using an advanced EpiSeal™ process, which eliminates foreign particles and improves long term aging and reliability
- World-class MEMS and CMOS design expertise

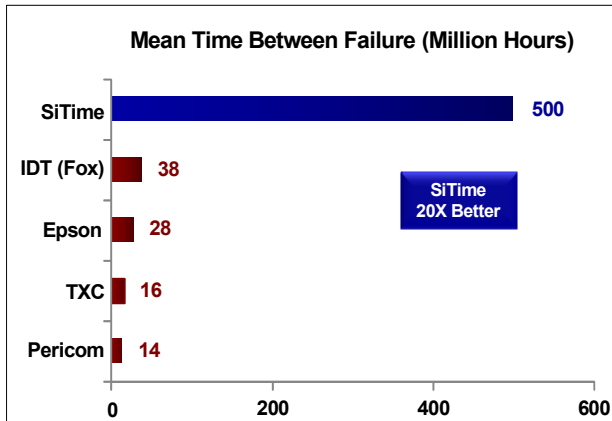

Figure 1. Reliability Comparison^[1]

Best Aging

Unlike quartz, MEMS oscillators have excellent long term aging performance which is why every new SiTime product specifies 10-year aging. A comparison is shown in Figure 2.

Why is SiTime Best in Class:

- SiTime's MEMS resonators are vacuum sealed using an advanced EpiSeal process, which eliminates foreign particles and improves long term aging and reliability
- Inherently better immunity of electrostatically driven MEMS resonator

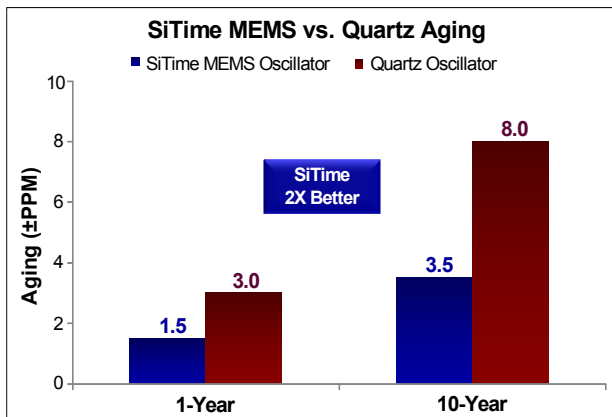

Figure 2. Aging Comparison^[2]

Best Electro Magnetic Susceptibility (EMS)

SiTime's oscillators in plastic packages are up to 54 times more immune to external electromagnetic fields than quartz oscillators as shown in Figure 3.

Why is SiTime Best in Class:

- Internal differential architecture for best common mode noise rejection
- Electrostatically driven MEMS resonator is more immune to EMS

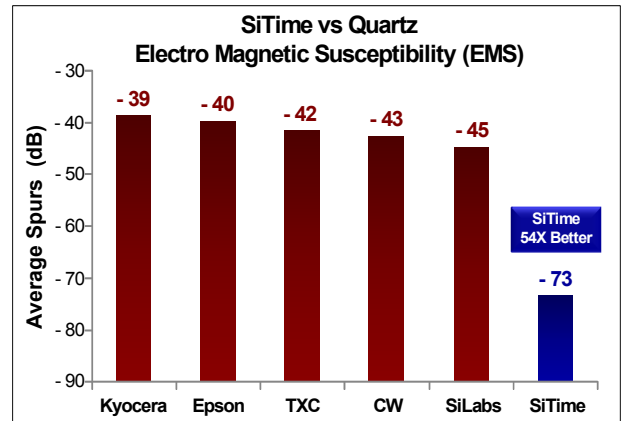

Figure 3. Electro Magnetic Susceptibility (EMS)^[3]

Best Power Supply Noise Rejection

SiTime's MEMS oscillators are more resilient against noise on the power supply. A comparison is shown in Figure 4.

Why is SiTime Best in Class:

- On-chip regulators and internal differential architecture for common mode noise rejection
- Best analog CMOS design expertise

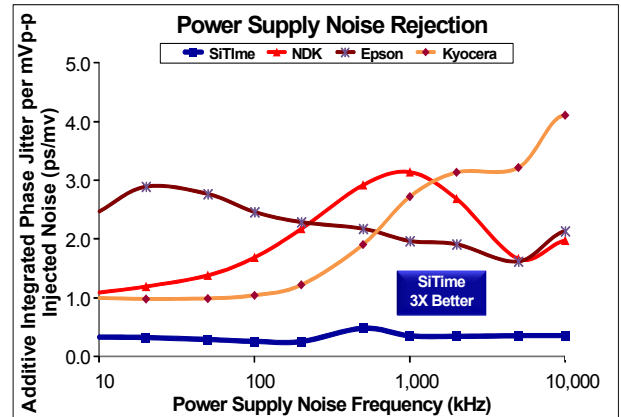

Figure 4. Power Supply Noise Rejection^[4]

Silicon MEMS Outperforms Quartz



The Smart Timing Choice™

Best Vibration Robustness

High-vibration environments are all around us. All electronics, from handheld devices to enterprise servers and storage systems are subject to vibration. Figure 5 shows a comparison of vibration robustness.

Why is SiTime Best in Class:

- The moving mass of SiTime's MEMS resonators is up to 3000 times smaller than quartz
- Center-anchored MEMS resonator is the most robust design

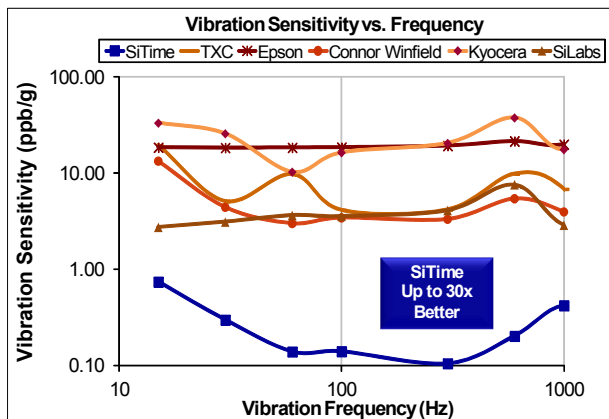

Figure 5. Vibration Robustness^[5]

Best Shock Robustness

SiTime's oscillators can withstand at least 50,000 g shock. They all maintain their electrical performance in operation during shock events. A comparison with quartz devices is shown in Figure 6.

Why is SiTime Best in Class:

- The moving mass of SiTime's MEMS resonators is up to 3000 times smaller than quartz
- Center-anchored MEMS resonator is the most robust design

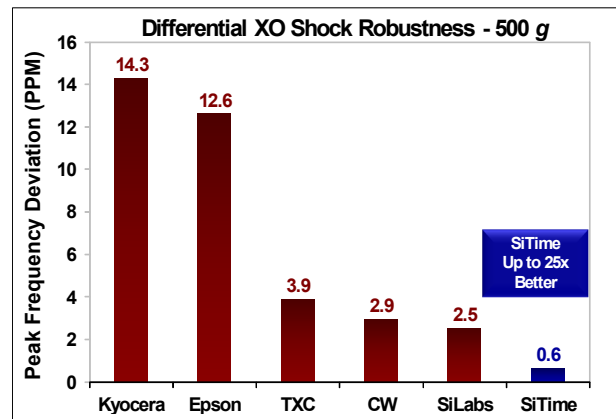

Figure 6. Shock Robustness^[6]

Notes:

1. Data Source: Reliability documents of named companies.
2. Data source: SiTime and quartz oscillator devices datasheets.
3. Test conditions for Electro Magnetic Susceptibility (EMS):
 - According to IEC EN61000-4.3 (Electromagnetic compatibility standard)
 - Field strength: 3V/m
 - Radiated signal modulation: AM 1 kHz at 80% depth
 - Carrier frequency scan: 80 MHz – 1 GHz in 1% steps
 - Antenna polarization: Vertical
 - DUT position: Center aligned to antenna
4. 50 mV pk-pk Sinusoidal voltage.

Devices used in this test:

 - SiTime, SiT9120AC-1D2-33E156.250000 - MEMS based - 156.25 MHz
 - Epson, EG-2102CA 156.2500M-PHPAL3 - SAW based - 156.25 MHz
 - TXC, BB-156.250MBE-T - 3rd Overtone quartz based - 156.25 MHz
 - Kyocera, KC7050T156.250P30E00 - SAW based - 156.25 MHz
 - Connor Winfield (CW), P123-156.25M - 3rd overtone quartz based - 156.25 MHz
 - SiLabs, Si590AB-BDG - 3rd overtone quartz based - 156.25 MHz
5. **Devices used in this test:** same as EMS test stated in Note 3.
6. Test conditions for shock test:
 - MIL-STD-883F Method 2002
 - Condition A: half sine wave shock pulse, 500-g, 1ms
 - Continuous frequency measurement in 100 μs gate time for 10 seconds

Devices used in this test: same as EMS test stated in Note 3
7. Additional data, including setup and detailed results, is available upon request to qualified customers. Please contact productsupport@sitime.com.



Document Feedback Form

SiTime values your input in improving our documentation. Click [here](#) for our online feedback form or fill out and email the form below to productsupport@sitime.com.

1. Does the Electrical Characteristics table provide complete information? Yes No

If No, what parameters are missing?

2. Is the organization of this document easy to follow? Yes No

If "No," please suggest improvements that we can make:

3. Is there any application specific information that you would like to see in this document? (Check all that apply)

EMI Termination recommendations Shock and vibration performance Other

If "Other," please specify:

4. Are there any errors in this document? Yes No

If "Yes", please specify (what and where):

5. Do you have additional recommendations for this document?

Name

Title

Company

Address

City / State or Province / Postal Code / Country

Telephone

Application

Would you like a reply? Yes No

Thank you for your feedback. Please click the email icon in your Adobe Reader tool bar and send to productsupport@sitime.com. Or you may use our [online feedback form](#).